

Technical Instruction Manual

DORROUGH LOUDNESS MONITOR Model 40-A

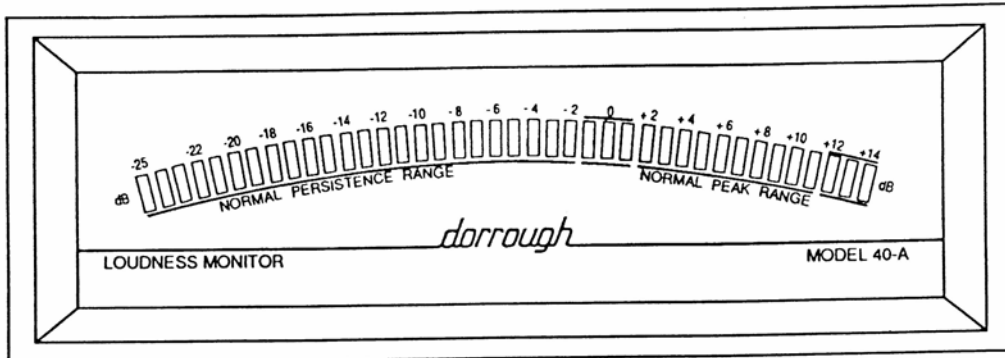

DORROUGH RELATIVE LOUDNESS TO PEAK MODULATION Model 40-B

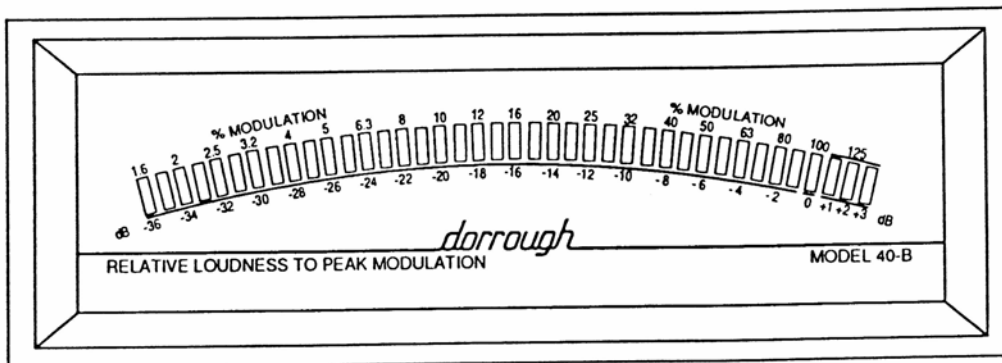

Also covers Models 10-A(B), 12-A(B), 20-A(B), and 21-A(B)

dorrough

DORROUGH ELECTRONICS
5221 Collier Place
Woodland Hills, CA 91364
(818) 999-1132

INTRODUCTION

Today's audio requires careful attention to precise level control. The consumer now has audio playback systems that stretch the limits of program dynamics. With all this new equipment, the modern listener is able to hear subtle differences in level and distortion within program material and make critical program choices based on the quality of sound.

Now it is more critical for the engineer to obtain the maximum loudness with the minimum of distortion components in order to fully utilize the dynamic range available. With the dynamic range that digital audio offers, and the bandwidth now available to film and video productions, it has become of paramount importance that there be a new method of monitoring and establishing the maximum safe level at which a system can operate.

The Weston (VU) Meter

The American Standard...

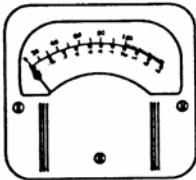

The Weston meter, introduced in 1939, was the standard for level monitoring. It met the then new standard for VU (Volume Unit) meters, and those same specifications are still the standard for all VU meters in use today. VU meters are really nothing more than voltmeters calibrated in power, and their ballistics were chosen to represent program material of the early days of radio and film.

A VU meter is classified as a quasi-average reading device. It almost completely ignores peak waveforms. With the somewhat arbitrarily chosen rise time of $300 \mu\text{s}$, engineers have developed certain compensations, such as riding dialogue 3 to 5 dB below music, to control the peak levels in an attempt to attain consistent listening levels. The standard broadcast practice is to allow for a crest factor of at least 10 dB to cover the peak excursions of the waveform that the VU meter is too slow to indicate.

The VU meter was never intended to provide acoustical comparisons between processed and unprocessed program material. Nor was it ever intended to provide indications of peak excursions. Clearly, the VU meter has some dramatic shortcomings with today's dynamic program material.

The PPM Meter

The European Standard...

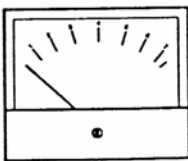

The PPM (Program Peak Meter) meter is not quite as old as the VU meter, being only about a forty-year-old standard, but like the old VU meter, the original standards are still on the books today. The PPM meter was the first answer to the obvious shortcomings of the VU meter, but, because it displays and holds only the peak level of the waveforms, the integration time of quasi-average program level is almost completely ignored.

The PPM also has a scale that does not relate directly to measured program levels, but only indicates relative levels. The numbers are arbitrary and could be just as well represented by fruit symbols or stick figures. Modern technology has eliminated the need to stare at a narrow mechanical needle oscillating in an analog motion to set level.

Peak hold circuits have been suggested as a solution, but while holding a peak reading, they ignore any information that occurs during the decay time. An engineer must make an adjustment, then wait while the peak hold circuit decays to get an indication of the new setting. Obviously this method cannot be used because of the need to respond to program material in real time.

Most contemporary studios have tried to solve their metering problems by using both VU and PPM meters on the same source in an attempt to get the maximum usable level out of a piece of program material. This has led to cramped and overly complex metering bridges and panels, and does not overcome the limitations inherent in these systems. Even the switchable bar graph meters offered as a solution by some console manufacturers suffer from the same ballistic limitations.

dorrough Loudness Meter

A new standard...

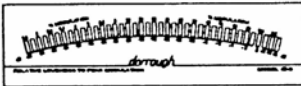

Years of hands-on experience and frustration with both VU and PPM metering led to the development of the DORROUGH Loudness Monitors. DORROUGH's research has established the relationship between integration time, RMS metering and the display of peak levels.

The DORROUGH Loudness Monitor displays, in an easy-to-read format, the actual energy content of the program material, regardless of frequency, while still indicating the peak amplitude of the complex audio signal. It allows the operator to ride levels in a manner such that all program material can be adjusted for equal perceived loudness while protecting the peak of the waveform. Now, one meter gives you more complete and more usable information than any combination of peak hold, VU and PPM indicators.

The DORROUGH Loudness Monitor integrates on the same scale, two ballistics, showing the relationship between the average and the peak. It simultaneously displays peak and average, and the relative difference, in dB, between these two ballistics is derived from the integration time of the persistence scale.

The operator has only to adjust the level until either the peak or persistence reference is reached. This will result in the maximum level, regardless of program content. Material with or without compression can easily be matched for the same listening level.

Each DORROUGH Loudness Monitor features Right and Left inputs for use in stereo mixing applications. With one instrument, the operator can easily see the stereo mix and avoid the classic in-phase/out-of-phase problem. "Center channel build-up," the addition of in-phase or monophonic material which causes the mix to be perceived as louder, will appear as a sudden increase in level. This is especially important in preparing stereo program material for broadcast, while still being able to maintain monaural compatibility.

INSTALLATION

To install your DORROUGH Loudness Monitor, perform the procedures described in the following sections.

Unpacking

Your DORROUGH Loudness Monitor was carefully packed at the factory. Take a moment to examine the unit for any signs of shipping damage. If damage is evident, retain the carton and notify the transit carrier and your local distributor about your claim.

Once you are satisfied with the physical integrity of the unit, proceed with Initial Set-Up to align the meter to match your operating level requirements.

Initial Set-up

You can set the operating level either on the bench or at the installation location. For set-up at the installation site, refer to the section on Mounting Considerations prior to performing the following procedure.

1. Plug the AC cord into a convenient AC line and observe that the display becomes backlit.



NOTE: If you do not see this action, make sure the AC line has power and the Power Switch (recessed in the back panel) is in the ON (up) position, or test the internal 0.25 A fuse for continuity.

2. While observing polarity, feed a 1000 Hz sine-wave at a standard operating level (i.e., -10, +4, +8, etc.) into the left input, as shown in Fig. 1.
3. Adjust the input level control (Fig. 1) on the rear panel for an indication of "0" on the meter scale. This step applies to all models.



NOTE: The peak excursion and the persistence amplitude are equal under steady state sine-wave conditions.

4. Next, remove the signal from the left channel and feed the signal in the same polarity to the right input, making the same adjustment.
5. Following the adjustments for both the left and right inputs, feed the signal to both inputs simultaneously. The summing amplifier will algebraically add the two inputs for an indication of +6, as read on the PEAK scale. This action applies only to an "A" Type meter; a "B" Type meter would be "off scale" for the same summing condition.

Continued on Page 4...

...Continued from Page 3

In actual practice, a "B" Type meter is generally used as a discrete monitor to indicate either a left or right channel. However, for Sum and Difference monitoring, repeat steps 3 and 4 (previous page), and adjust each input level control for a -6 dB indication on the meter scale for an individual channel. This action will result in a proper sum of "0" on the "B" Type meter scale.

NOTE: Different amplitudes and phase angles between the left and right input signals will produce different algebraic sums. This display is essential in indicating center channel buildup in some program material and will aid an operator in making the proper adjustment to program operating level. For mono signals, use the suggested connections shown in Fig. 2.

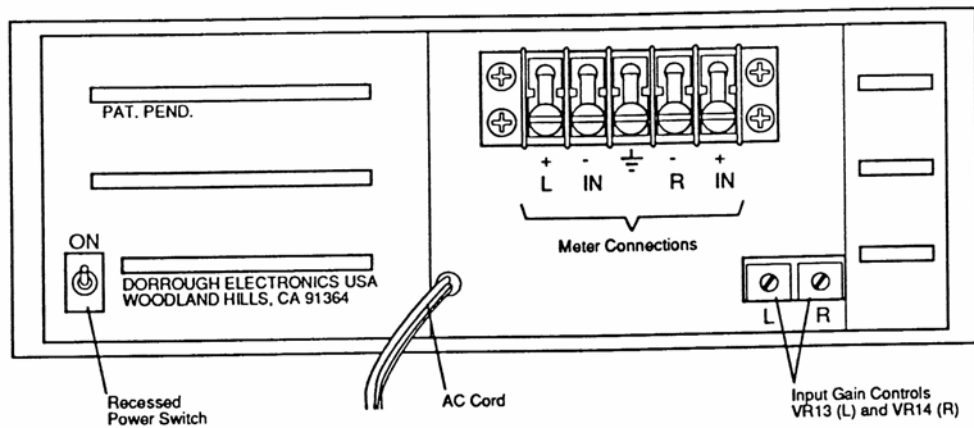

Fig. 1. Back panel of DORROUGH Loudness Monitor, Model 40-A or Model 40-B.

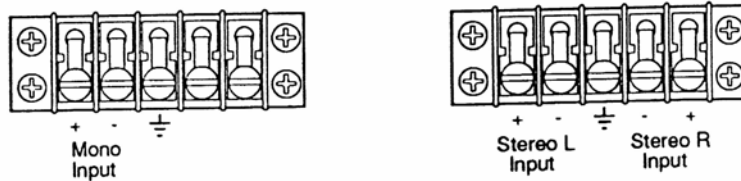

Fig. 2. Meter connections for mono and stereo input signals. For mono use, connect mono input signal to L+ and L- terminals and turn R Input Gain Control to the full counterclockwise position.

Mounting Considerations

The DORROUGH Loudness Monitor is available with or without a case, and is manufactured in several versions to accommodate differing customer needs. For example, "A" Type models are the standard Loudness Monitors, while "B" Type models measure Relative Loudness to Peak Modulation (see front cover).

Fig. 3 and Fig. 4 show the physical specifications for mounting one or two meters with their cases in a rack panel. Fig. 5 shows the physical mounting specifications for each panel mount model (no case), while Fig. 6 illustrates the procedure for installing a panel mount meter.

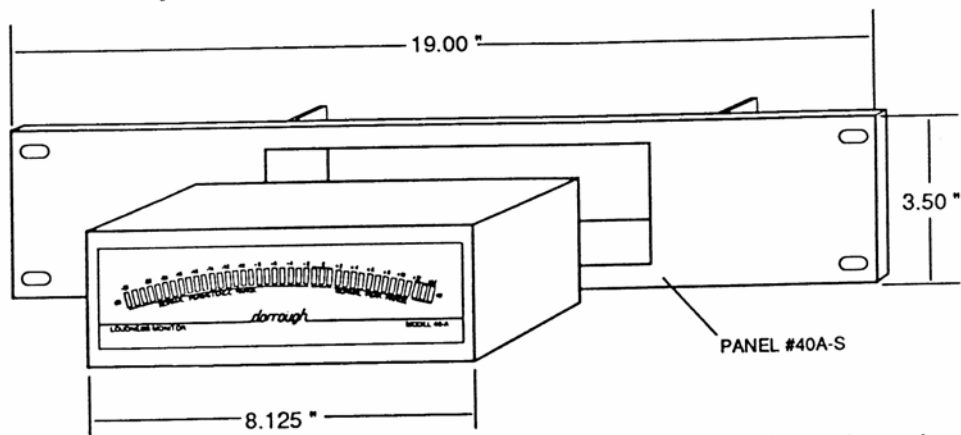

Fig. 3. Physical specifications for mounting a single meter in a rack panel. As an installation aid, an optional rack panel (40A-S) is available from the factory. Meter slides in from the back and is fastened to the tray with two 4-40 x 3/4" screws.

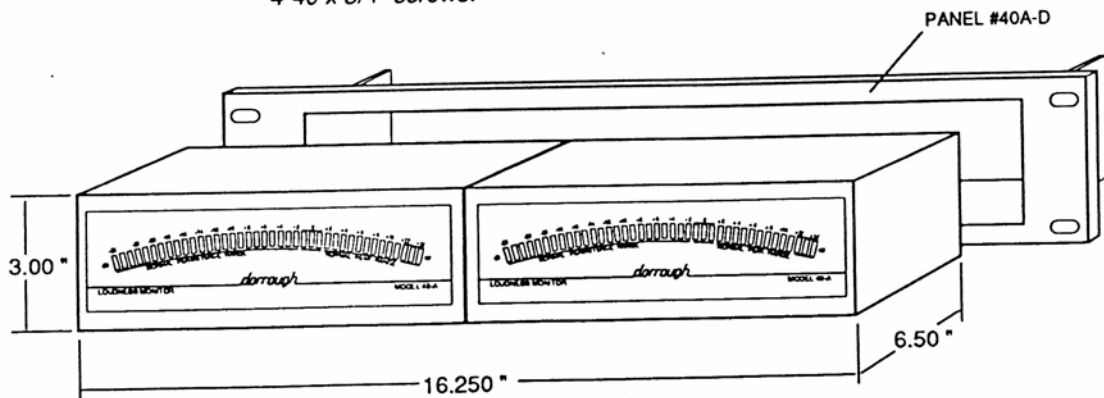
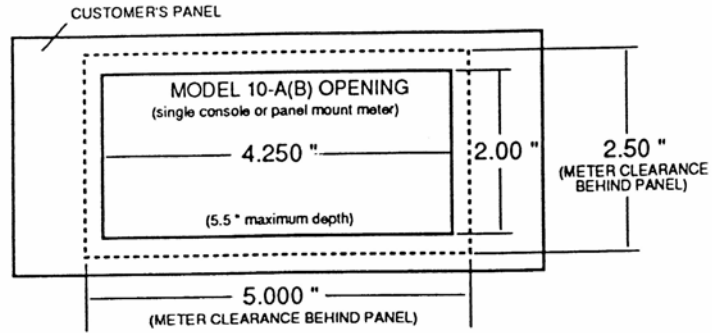
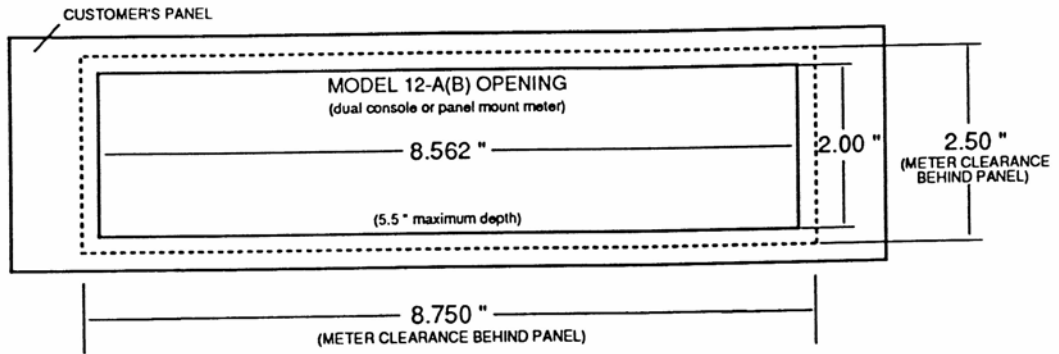

Fig. 4. Physical specifications for mounting two meters in a standard rack panel. As an installation aid, an optional rack panel (40A-D) is available from the factory. Meter slides in from the back and is fastened to the tray with four 4-40 x 3/4" screws.



(a) Model 10-A(B) panel mount specifications.



(b) Model 12-A(B) panel mount specifications.

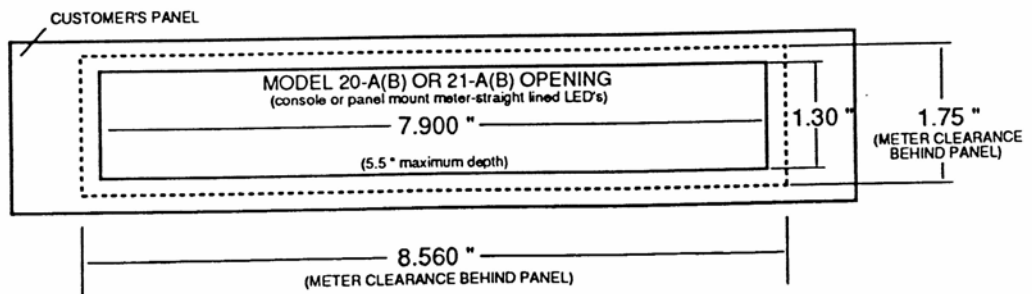

(c) Model 20-A(B) or Model 21-A(B) panel mount specifications. Model 21-A(B) is a vertical panel mount meter.

Fig. 5. Physical specifications for several panel mount models.

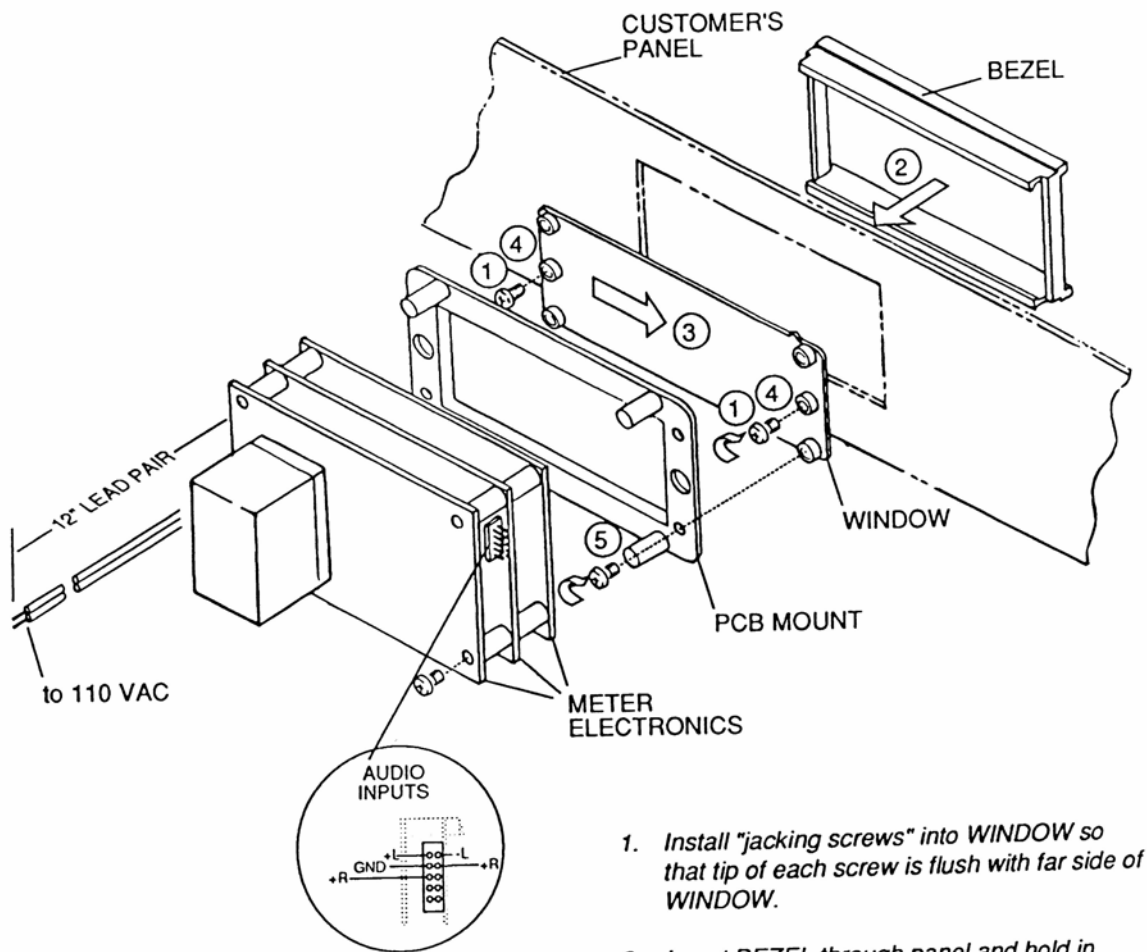

1. Install "jacking screws" into WINDOW so that tip of each screw is flush with far side of WINDOW.
2. Insert BEZEL through panel and hold in place by hand.
3. Slide WINDOW into BEZEL.
4. Center the WINDOW and turn the "jacking screws" clockwise, until BEZEL is pulled snug against the panel.
5. Secure the PCB mount to the WINDOW at outboard holes with four screws.

Fig. 6. Installation procedure for mounting a panel mount meter. Follow the listed steps while referring to the guide numbers in the illustration.

OPERATION & APPLICATIONS

Operation

Stereophonic material, in the form of left and right inputs, is fed to the meter at the terminal strip located in the rear of the meter, as shown in Fig. 1. Individual gain controls for the left and right inputs are also located on the rear panel.

These sources feed a 20K balanced bridging amplifier. Unbalanced 10K bridging input is accomplished by converting the minus (-) input terminal to chassis ground on the rear terminal strip.

The meter is shipped with each individual input control set for +4 dB as referenced to "0" on the meter face. Levels as low as -30 dB can be referenced to "0" by changing the value of R-18 from 20K to 100K. Refer to Fig. 15 and Fig. 16 for the location of this component on the Power and Signal Board.

If your program reference is different than that of +4 dB, simple adjustments to some other standard can be made by the following the procedure listed in the Field Alignment section.

Applications

DORROUGH Loudness Monitors can be used in a number of applications, as shown in Fig. 7 through Fig. 13, including: Telephone/Transmission, AM Mono Broadcast, Analog/Digital Tape Saturation Monitor, Sum & Difference Monitor, Stereo Television Broadcast, Disk Mastering, and Sound Reinforcement.

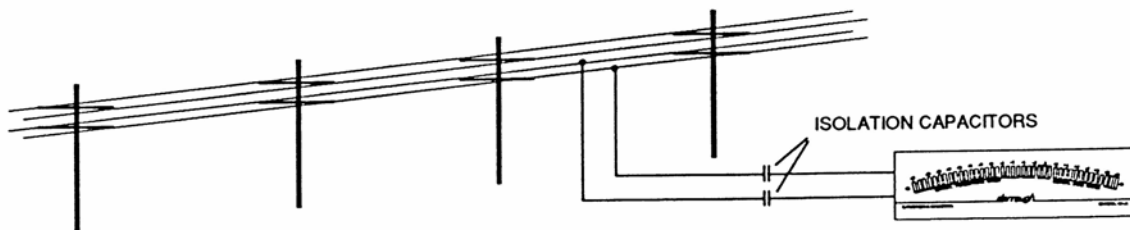

Fig. 7. Telephone and/or Transmission Applications. The DORROUGH Loudness Monitor ("A" Type or "B" Type) can be utilized to monitor power line condition or telephone line signal, as shown in the above line drawing. Make sure that some form of isolation, either transformers or capacitors, is used in this application.

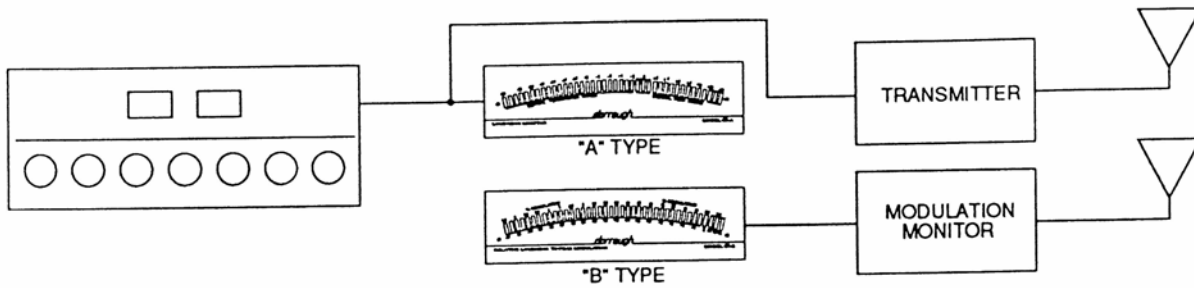

Fig. 8. Broadcast Monaural Applications. This line drawing shows a typical broadcast application. Most stations use an "A" Type DORROUGH Loudness Monitor to monitor the "unprocessed" Transmitter signal and either an "A" or "B" Type DORROUGH Loudness Monitor to verify the Off-Air signals in real time. The "B" Type Monitor is the preferred instrument for verifying peak headroom.

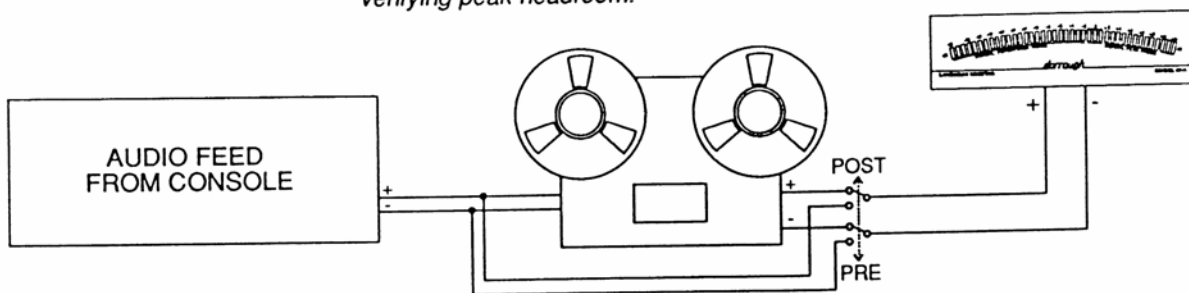

Fig. 9. Analog/Digital Tape Saturation Monitor. This interconnect drawing shows an example of monitoring tape saturation by comparing pre- and post-tape signal levels. Once saturation is reached, the post-tape readings will no longer track increases in pre-tape signal levels. NOTE: This example assumes the tape deck is aligned for unity gain. Although a "B" Type DORROUGH Loudness Monitor is preferred, an "A" Type is acceptable.

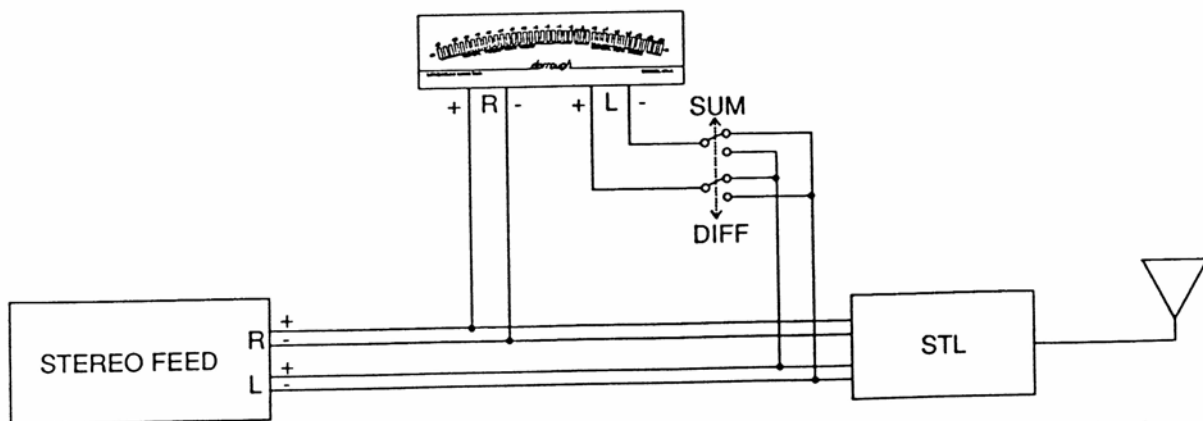

Fig. 10. Sum and Difference Monitor (1 Meter). This interconnect drawing shows a Sum and Difference Monitor setup by utilizing a single "A" or "B" Type DORROUGH Loudness Monitor.

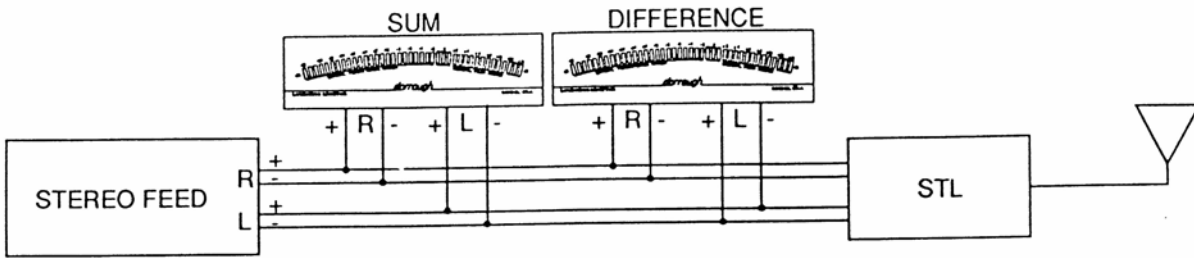

Fig. 11. Sum and Difference Monitors (2 Meters). This interconnect drawing shows a Sum and Difference Monitor setup by utilizing two "A" or "B" Type DORROUGH Loudness Monitors. In this application, Sum and Difference signals can be monitored in real time.

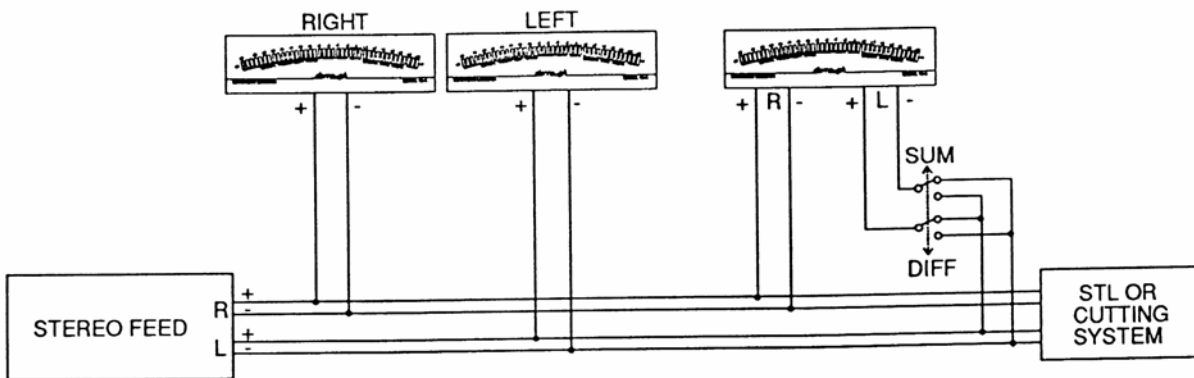

Fig. 12. Broadcast Stereo or Disk Mastering Applications. This interconnect drawing shows a typical setup for monitoring stereo signals in real time. In addition, a selectable Sum or Difference Monitor allows the operator to check the critical phase integrity of the monitored signals. Use either "A" Type or "B" Type DORROUGH Loudness Monitors.

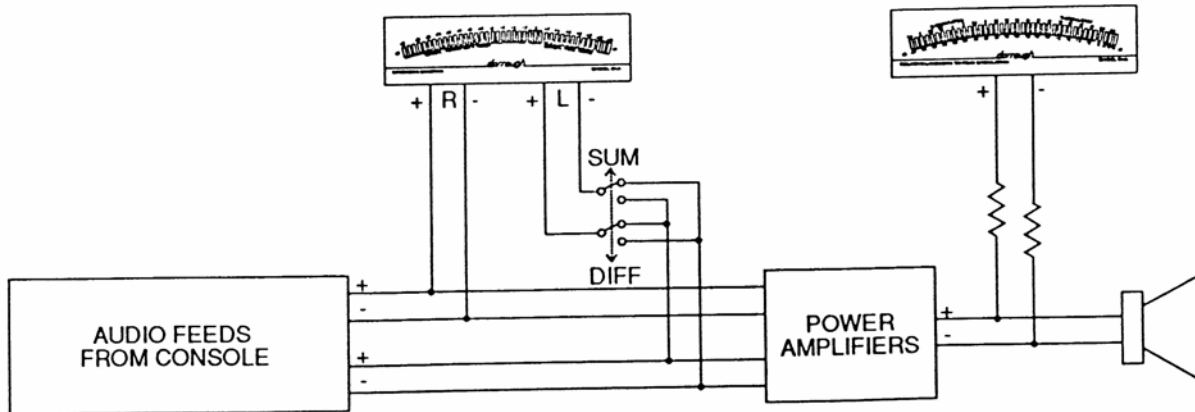



Fig. 13. Sound Reinforcement Applications. An "A" Type DORROUGH Loudness Monitor can be utilized to verify phase integrity of signal pairs feeding a bank of power amplifiers. In addition, a "B" Type DORROUGH Loudness Monitor can be used (with bridging resistors) to monitor the outputs for any power amplifier failure.

CIRCUIT THEORY

The circuits that make up the DORROUGH Loudness Monitor (and Relative Loudness to Peak Modulation meter) are grouped onto two circuit boards: an Input Signal Processing Board (including Power Supply), and a Bar and Peak Driver Circuit Board.

 **NOTE:** On Panel Type Meters, the Power Supply is a separate circuit board.

A block diagram, shown in Fig. 14, discloses the circuit elements and connections in a simplified form. Refer to this diagram, as well as the circuit schematics (back of manual), throughout the following discussion.

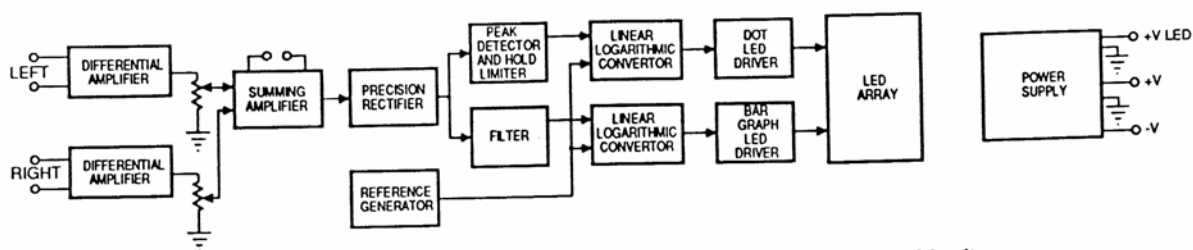

Fig. 14. Block Diagram of DORROUGH Loudness Monitor.

The input is fed into the left and right differential amplifiers. The differential inputs are configured so that the input impedance is 20K for balanced inputs and 10K for unbalanced inputs (negative terminal is grounded for unbalanced operation).

The left input level is controlled by R-13 and the right input by R-14. The output of these two controls are fed to a summing amplifier. The feedback resistor R-18 controls the input sensitivity of the instrument. As shipped, the value of R-18 is 20K, which provides an input sensitivity of -18 dB. Changing the value of R-18 to 100K increases the sensitivity to -30 dB.

The output of the summing amplifier feeds a precision rectifier. The output of the precision rectifier feeds a split to the PEAK and PERSISTENCE circuits.

Since the desired display is to be logarithmic, the signals are fed to corresponding "linear/logarithmic" converters. The outputs of these converters feed the display drivers. The driver for the PEAK display is configured as a dot, while the driver for the PERSISTENCE display is configured as a bargraph.

Each of the 40 LEDs derives an input from both of the drivers (only on all "A" Type Monitors), with the exception of the red LEDs designated as -1, 0,+1. These particular LEDs have no input from the dot driver, and therefore do not display PEAK information. This provision was made to eliminate possible confusion relative to PEAK and PERSISTENCE amplitudes at this reference. With the exception of these LEDs, a steady state sine-wave will illuminate a bargraph at a given amplitude, with the last displayed LED brighter than the remainder. This gives indication that the amplitude of the PERSISTENCE and the amplitude of the PEAK are equal, showing proper alignment of the instrument.

FIELD ALIGNMENT

To occasionally check the accuracy of your DORROUGH Loudness Monitor, perform the Field Alignment listed in this section. Although the meter is designed for exceptionally stable performance, you may want to satisfy your curiosity or verify performance after a change has been made.

All adjustments for the alignment of the LED display are located on the Input Signal Processing Board. To gain access to these controls (40-A and 40-B Models), the instrument is placed bottom-side-up and the six screws are removed. Once the screws are removed, place the unit right-side-up and the cabinet can be lifted from the remainder of the chassis, exposing the adjustments. Refer to Fig. 15 for circuit board part locations as you perform the following instructions. Use Fig. 16, Fig. 17, and Fig. 18, for Panel Type Models 10-A(B), 12-A(B), 20-A(B), and 21-A(B).

"A" Type Monitor Alignment Procedure

1. Connect the output from a test oscillator to the meter's left input terminals (see Fig. 1).
2. Feed a 1000 Hz sine-wave, at a reference level of "0" dB, into the meter.
3. Adjust the left input gain control VR-13 so that DS-1 is off and DS-2, -3, -4 are on.
4. Adjust the input signal to -25 dB.
5. Adjust the low PERSISTENCE level control VR-44 so only the first LED (-25 dB on meter scale) at the bottom of the PERSISTENCE scale is illuminated.
6. Adjust the low PEAK level control VR-46 so only the first LED (-25 dB on meter scale) at the bottom of the PERSISTENCE scale brightens.

 *NOTE: This indicates that both the PEAK and the PERSISTENCE drivers are providing current to this LED.*

7. Change the input signal to +5 dB (a 30 dB increase).
8. Adjust the high PERSISTENCE level control VR-48 so that the bargraph illuminates LEDs up to and including the +5 dB LED.
9. Adjust the high PEAK level control VR-49 so that the +5 dB LED brightens.

 *NOTE: This indicates that both the PEAK and the PERSISTENCE drivers are both providing current to this LED.*

10. Increase input signal to +14 dB and observe that the +14 dB LED illuminates.

 *NOTE: The +14 dB LED should indicate drive from both PEAK and PERSISTENCE drivers.*

11. Decrease input signal to +13 dB ; observe that the +14 dB LED turns off.
12. Decrease input signal to +4 dB and adjust VR-13 for 0 dB on the scale.
13. Then, feed input signal of +4 dB to right input terminals, and adjust VR-14 for 0 dB on the scale. This duplicates the factory settings.
14. After both channels have been aligned, follow the procedure for setting-up the operating level as described in the Initial Set-Up section (see Installation).

Once you have completed this procedure, re-assemble the meter and place the unit back in service.

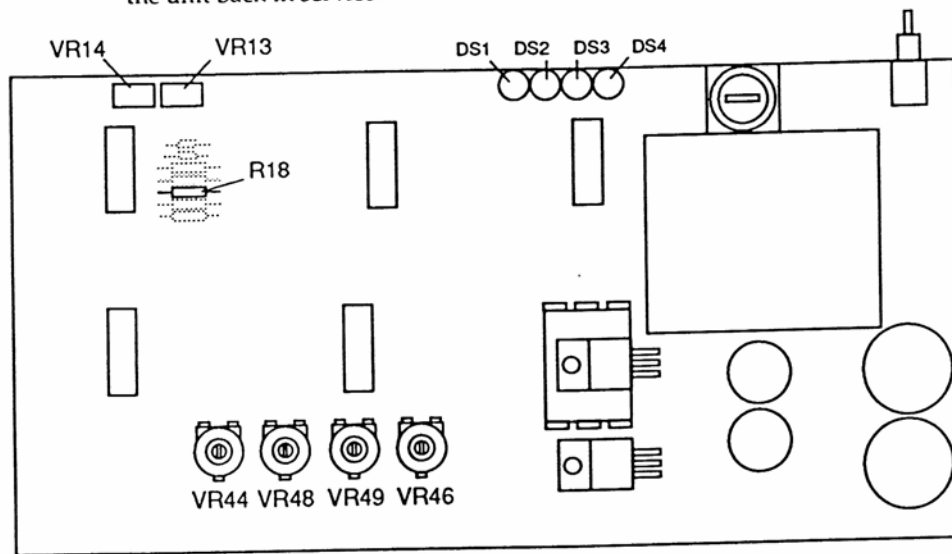

POWER & SIGNAL BOARD

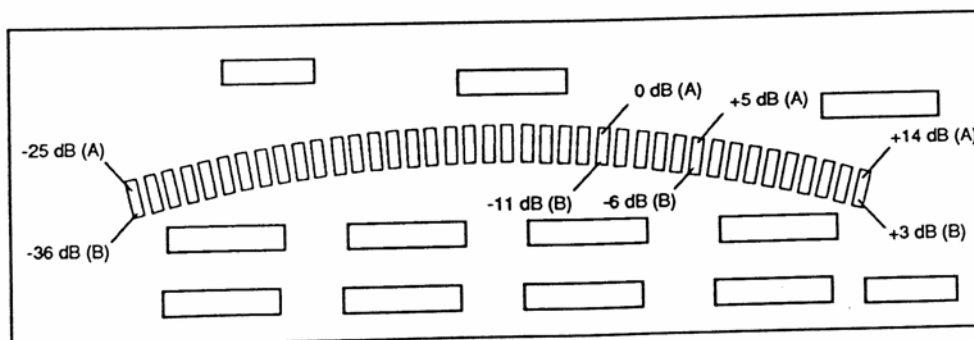

LED DRIVER BOARD

Fig. 15. Simplified view of key alignment components on Model 40-A (40-B) circuit boards.

"B" Type Monitor Alignment Procedure

1. Connect the output from a test oscillator to the meter's left input terminals (see Fig. 1).
2. Feed a 1000 Hz sine-wave, at a reference level of "0" dB, into the meter.
3. Adjust the left input gain control VR-13 so that DS-1 is off and DS-2, -3, -4 are on.
4. Adjust the input signal to -25 dB.
5. Adjust the low PERSISTENCE level control VR-44 so only the first LED (-36 dB on meter scale) at the bottom of the PERSISTENCE scale is illuminated.
6. Adjust the low PEAK level control VR-46 so only the first LED (-36 dB on meter scale) at the bottom of the PERSISTENCE scale brightens.

 *NOTE: This indicates that both the PEAK and the PERSISTENCE drivers are providing current to this LED.*

7. Change the input signal to +5 dB (a 30 dB increase).
8. Adjust the high PERSISTENCE level control VR-48 so that the bargraph illuminates LEDs up to and including the -6 dB LED.
9. Adjust the high PEAK level control VR-49 until the -6 dB LED brightens.

 *NOTE: This indicates that both the PEAK and the PERSISTENCE drivers are both providing current to this LED.*

10. Increase input signal to +14 dB and observe that the +3 dB LED illuminates.

 *NOTE: The +3dB LED should indicate drive from both PEAK and PERSISTENCE drivers.*

11. Decrease input signal to +13 dB ; observe that the +3 dB LED turns off.
12. Decrease input signal to +4 dB and adjust VR-13 for -11 dB on the scale.
13. Then, feed input signal of +4 dB to right input terminals, and adjust VR-14 for -11 dB on the scale. This duplicates the factory settings.
14. After both channels have been aligned, follow the procedure for setting-up the operating level as described in the Initial Set-Up section (see Installation).

Once you have completed this procedure, re-assemble the meter and place the unit back in service.

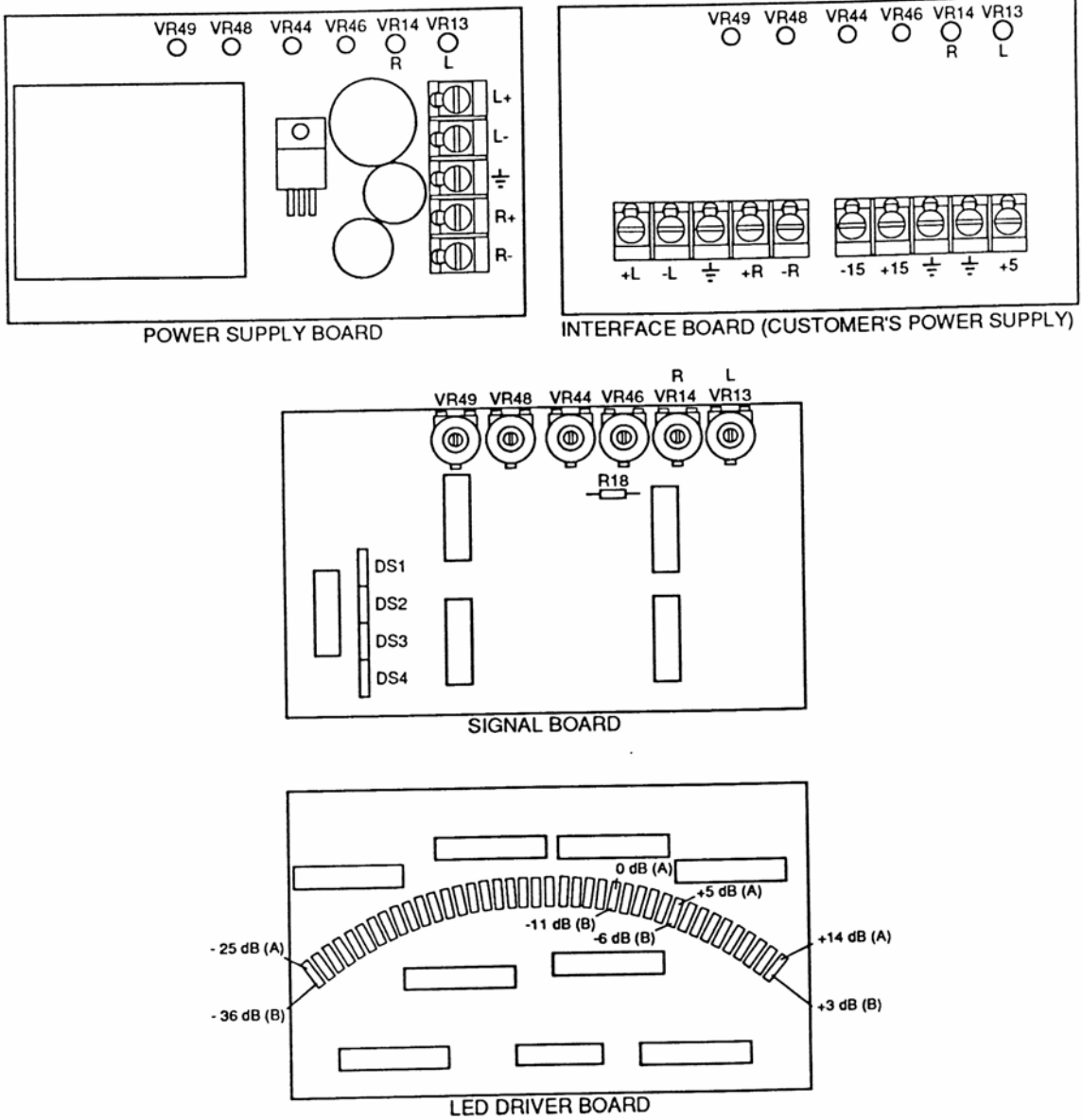
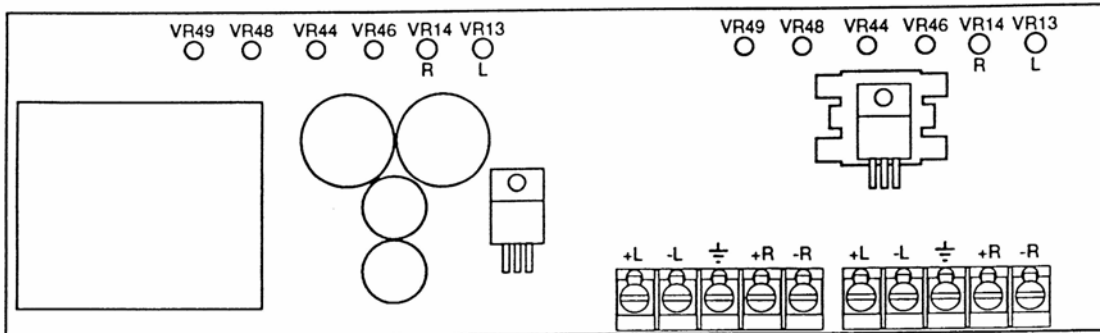
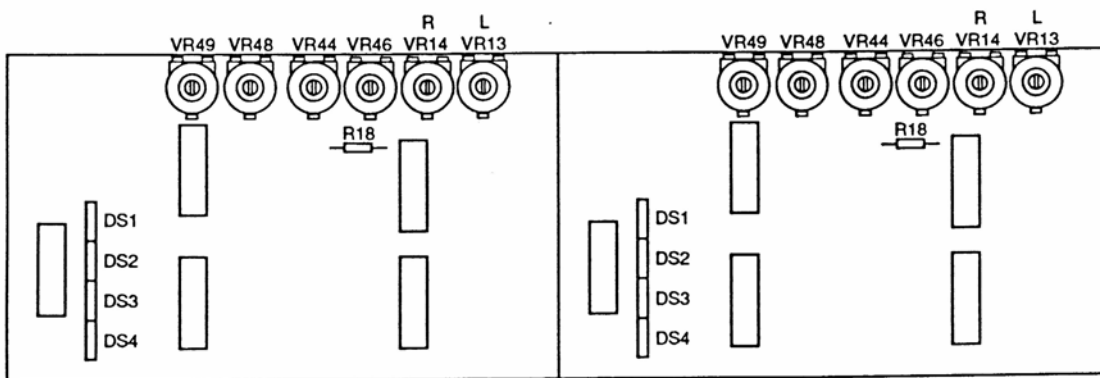

Fig. 16. Simplified view of key alignment components on Model 10-A (10-B) circuit boards. Refer to Fig. 5 and Fig. 6 for specific panel mounting instructions. An optional Interface Board is available from the factory (as a replacement for the standard Power Supply Board) for use with a customer's power supply.



POWER SUPPLY BOARD



2 SIGNAL BOARDS

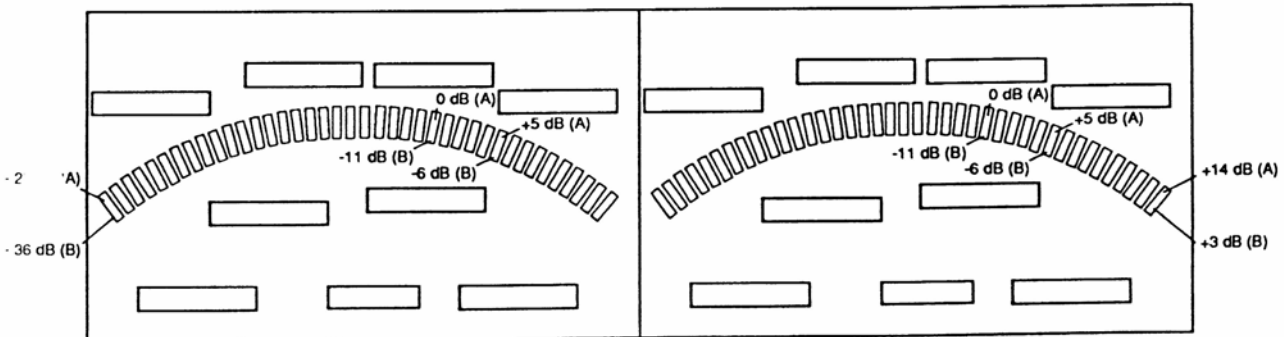

2 LED DRIVER BOARDS

Fig. 17. Simplified view of key alignment components on Model 12-A (12-B) circuit boards. Refer to Fig. 5 and Fig. 6 for specific panel mounting instructions. Check with the factory on availability of an optional Interface Board (as a replacement for the standard Power Supply Board) for use with a customer's power supply.

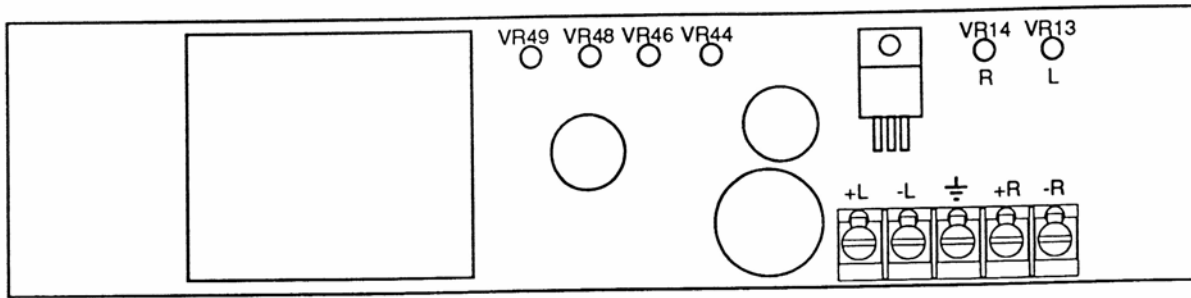

POWER SUPPLY BOARD

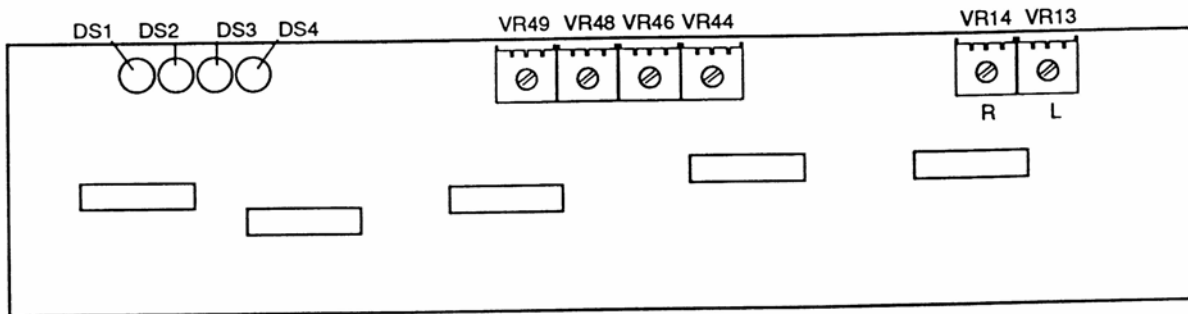

SIGNAL BOARD

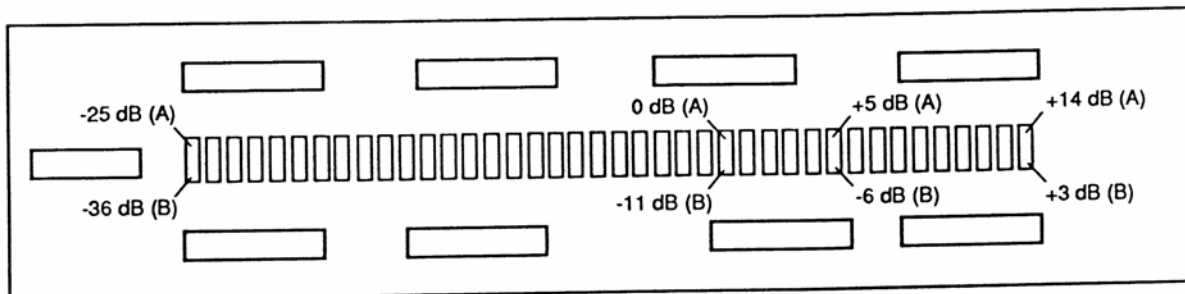

LED DRIVER BOARD

Fig. 18. Simplified view of key alignment components on horizontal Model 20-A (20-B) or vertical Model 21-A (20-B) circuit boards. Refer to Fig. 5 and Fig. 6 for specific panel mounting instructions. Check with factory on availability of an optional Interface Board (as a replacement for the standard Power Supply Board) for use with a customer's power supply.

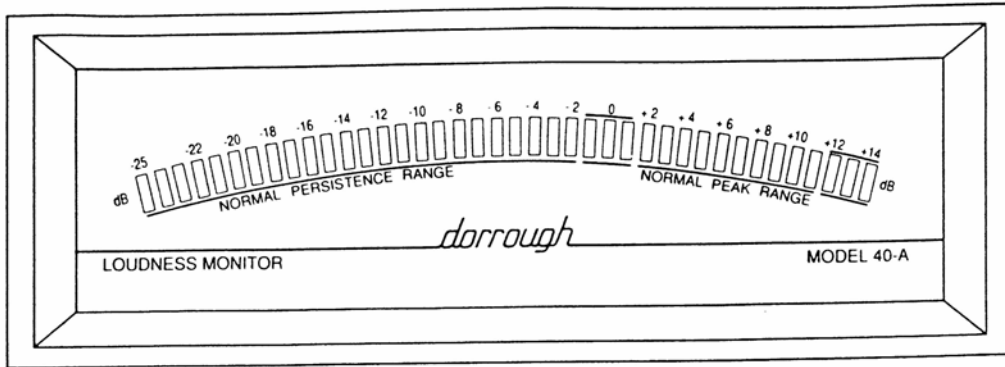

DORROUGH LOUDNESS METER, Model 40-A

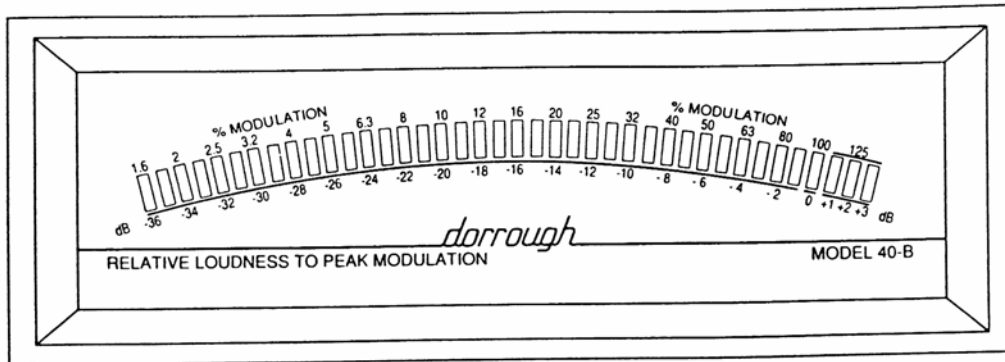

DORROUGH RELATIVE LOUDNESS TO PEAK MODULATION METER, Model 40-B

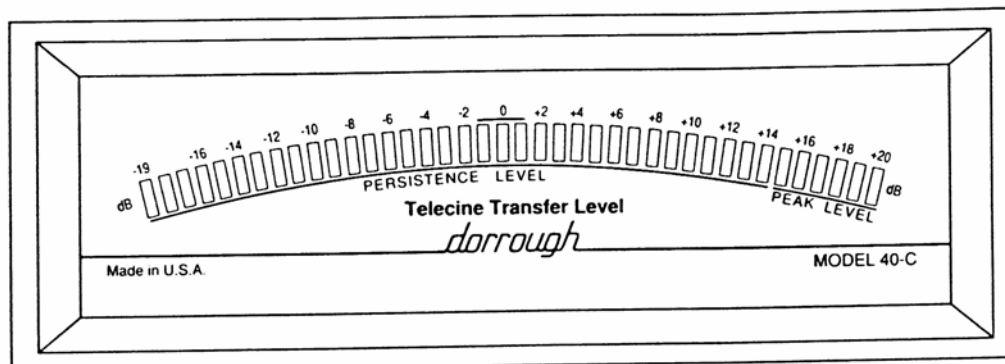

DORROUGH TELECINE TRANSFER LEVEL METER, Model 40-C

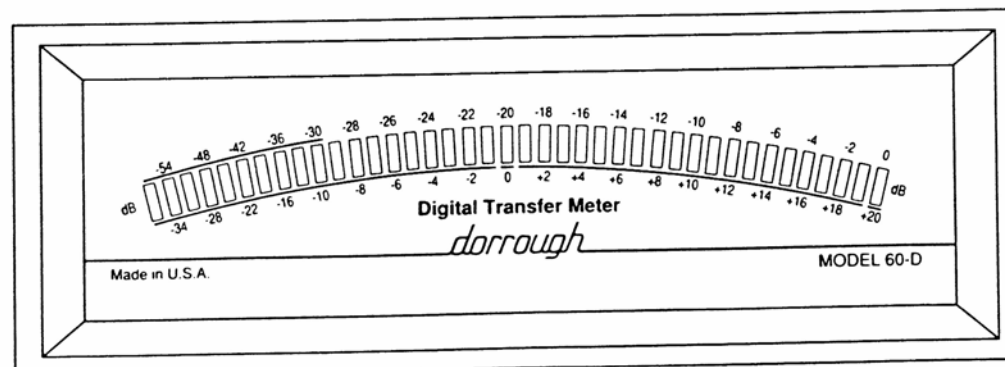

DORROUGH DIGITAL TRANSFER METER, Model 60-D

REVISED DORROUGH METER CALIBRATION PROCEDURE

Check R15 and R16 for a 10k resistor. If 10K, perform the calibration procedure with values of -20dBu instead of -40dBu, and +20dBu instead of 0, in steps 1 and 5. With a 1k or 2k resistor in R15 and R16, proceed as follows:

1. Apply a -40dBu signal to left channel input.
2. Adjust VR13 (L) until DS4 on signal board is illuminated (DS1, DS2, and DS3 are dark).
3. Adjust VR46 (Peak Low Set) for $.05 \pm .03V$ at TP8. Repeat procedure with VR44 (Average Low Set) at TP9. Average is very slow at bottom of range.
4. Measure voltage at Pin 7 of U9 on LED board. This voltage should read approximately 4.00V. On Models 40 and 60D40, this is adjustable by VR1 (adjust for 4.00V).
5. Increase signal to 0dBu. Adjust at TP8, VR49 (Peak High Set) for 4.00V found at step 4, and add .05V. Repeat procedure with VR8 (Average High Set) at TP9.
6. Check step 3 and re-adjust as necessary.
7. Check step 5 and re-adjust as necessary.
8. Calibration complete. Apply nominal reference to input and adjust VR13 for "0" on the display.

Dorrrough Peak and Average Reading Meters

The display of both peak and average is the trademark of the Dorrough line of award winning audio meters.

When average loudness is visible under the transient peaks, an operator can make informed judgements that result in better audio quality.

Average, peak, and the presence of excessive compression are visible.

The meter very clearly displays the three dimensions of program material content.

Video Level Meters

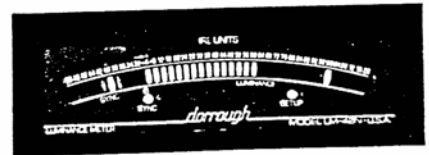

Video Luminance Meter Model 40-N

An NTSC Video Level Meter that displays the video signals of average and peak luminance, sync level, and setup violations. Sync range -50 to -32 IRE. Meter resolution 4 IRE per LED.

Model 40-N \$750.00

Analog Reading Meters



Dual Meters Model 40-A(B)

Both the Model 40-A and 40-B are available in standard rack panels as either dual (stereo) or single (mono) units.

Model 40-S1 (single rack) \$45.00
Model 40-D1 (dual rack) \$45.00



Loudness Meter Model 40-A

The Standard Loudness Meter Model 40-A has a scale allowing 14 dB of headroom in 1 dB steps. It is a stand alone unit, has an internal power supply, and measures 8 1/2" x 2 3/8" x 6 1/2". A peak-hold option is available.

Model 40-A \$475.00
Model 40-AP \$595.00



Dual Meters Model 20-A

The Model 20-A is a straight line version of the Standard Model 40-A. Available as a single or dual.

Model 20-A (B) \$475.00
Model 20-S1 (single rack) \$45.00
Model 20-D1 (dual rack) \$45.00

Digital Reading Meters



AES/EBU 2-Channel Audio Meter Model 280-D and 380-D

The Models 280-D and 380-D are AES/EBU reading and feature display of both peak and average simultaneously, over indication, and selectable peak-hold. Conforms to all specifications of AES 3 1992.

Model 280-D (40 dB) (H) \$850.00
Model 280-E (60 dB) (H) \$850.00
Model 380-D (40 dB) (V) \$850.00
Model 380-E (60 dB) (V) \$850.00

Audio Test and Measurement

Stereo Signal Test Set Model 1200

A Stereo Signal Test Set for measurement of level, balance, crosstalk, and phase with left, right, L/R, and Sum/Diff modes and a range of 100 dB.

Model 1200 \$1650.00



2-Channel Meter Model 280-A and 380-A

The Models 280-A and 380-A feature a single meter with two channels of audio and selectable peak-hold functions. The meter measures 1 1/2" x 5" and has an external power supply.

Model 280-A (H) \$850.00
Model 380-A (V) \$850.00

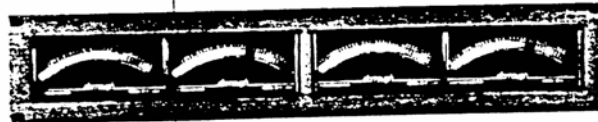

Loudness Meter Model 12-A

The Model 12-A is a dual version of the 10-A measuring 8 1/2" x 3". Two of these meters mount into a standard rack for a total of four metering channels.

Model 12-A (B) \$950.00
Model 12-D (dual rack) \$45.00



dorrrough

Dorrrough Electronics • Woodland Hills, CA 91364

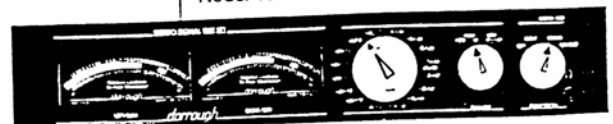

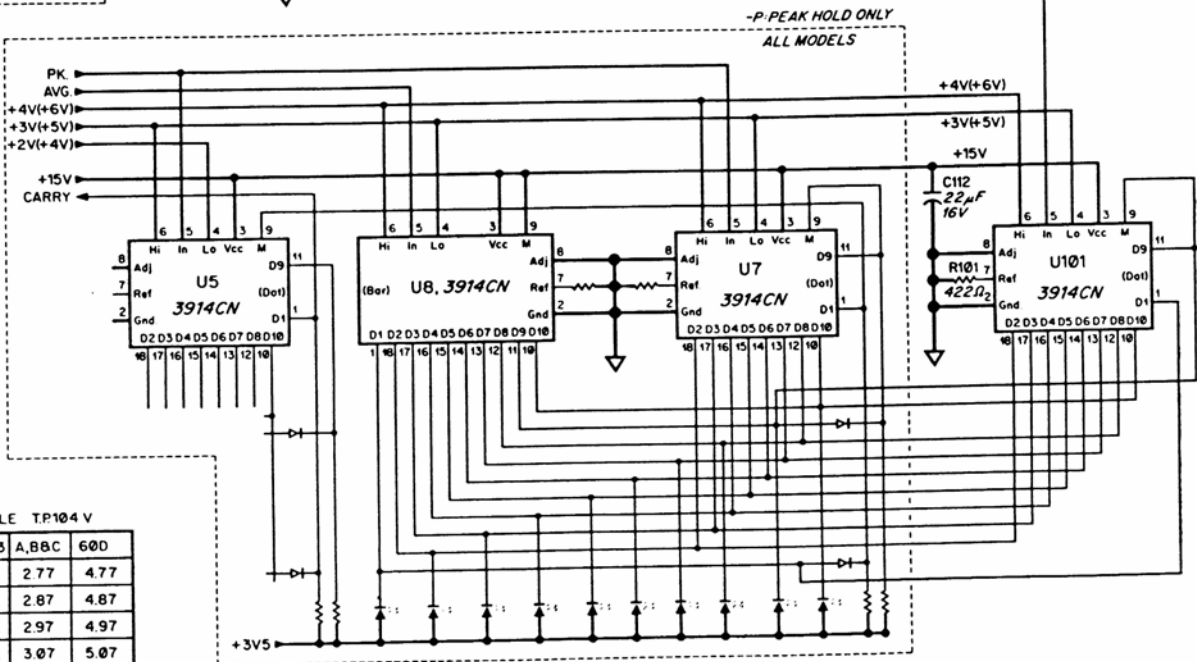
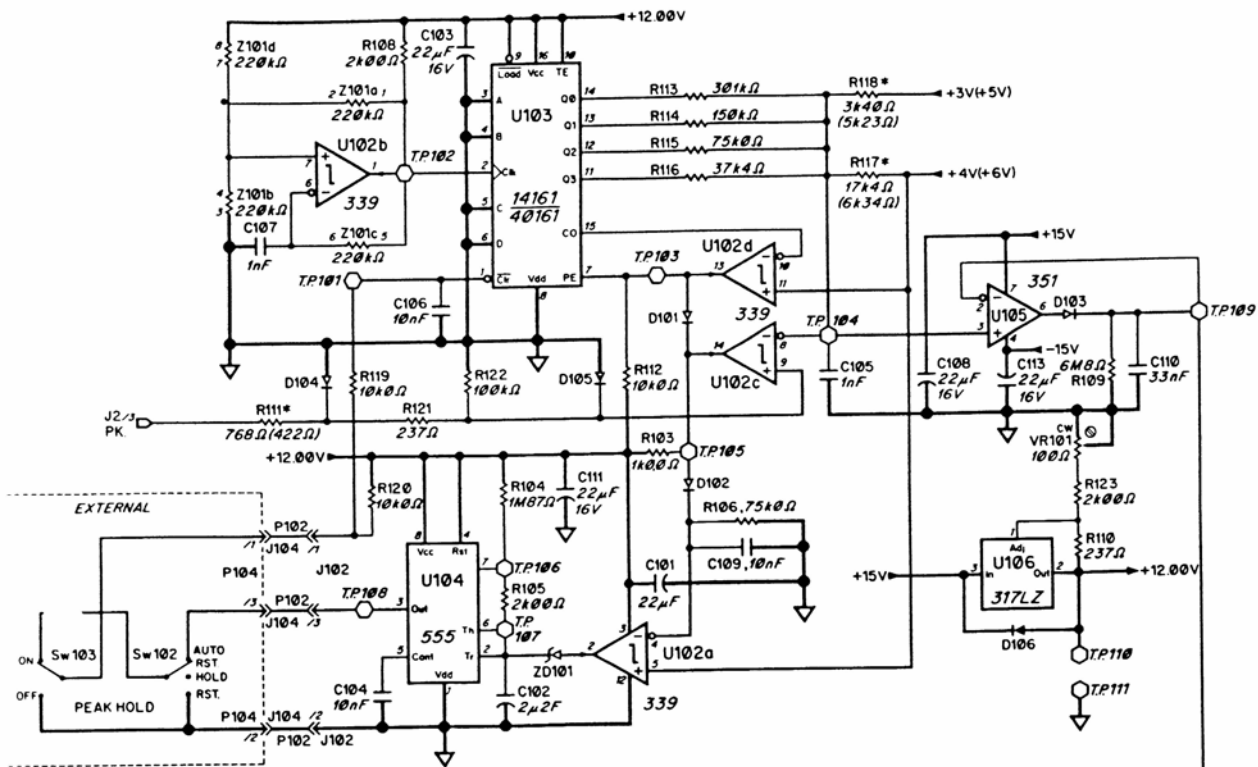

D/A SEQUENCE TABLE T.P104 V

STEP	Q0	Q1	Q2	Q3	A,BBC	60D
0	L	L	L	L	2.77	4.77
1	H	L	L	L	2.87	4.87
2	L	H	L	L	2.97	4.97
3	H	H	L	L	3.07	5.07
4	L	L	H	L	3.17	5.17
5	H	L	H	L	3.27	5.27
6	L	H	H	L	3.37	5.37
7	H	H	H	L	3.47	5.47
8	L	L	L	H	3.57	5.57
9	H	L	L	H	3.67	5.67
10	L	H	L	H	3.77	5.77
11	H	H	L	H	3.87	5.87
12	L	L	H	H	3.97	5.97
13	H	L	H	H	4.07	6.07
14	L	H	H	H	4.17	6.17
15	H	H	H	H	4.27	6.27

4 7815 SELECTED FOR 15: 05V

3 () = "D" VERSION VALUES

2 — = FEMALE/TB

→ = MALE

—|— = 1N4002

—|— = 1N34A

—|— = 1N4148/914

—|— = 1N749A/1N5229B

1 ALL VALUES:

A. MULTIPLIER AT DECIMAL LOCATION, i.e.

3.6kΩ = 3.6 × 10³Ω, 0.047μF = 4.7 × 10⁻²μF = 47nF, 22μF = 22 × 10⁰μF = 22μF

B. p = 10⁻¹², n = 10⁻⁹, μ = 10⁻⁶, m = 10⁻³, k = 10³, M = 10⁶, G = 10⁹

NOTES: UNLESS OTHERWISE SPECIFIED

APPROVALS	DATE	dorough	
DRAWN E.A.		DESCRIPTION	SCHEMATIC DIAGRAM
CHECKED		APP'D	MD
ENGR K.G.		MODEL-P/N	MODELS 40A-C, 60D40
APP'D M.D.		SIZE	REV F
MATL N/A		SCALE	2/1
FINISH		STATE OF DWG	FINAL
		SHEET	2 OF 2